

Connaissance du manche

Schéma de l'ensemble des notes

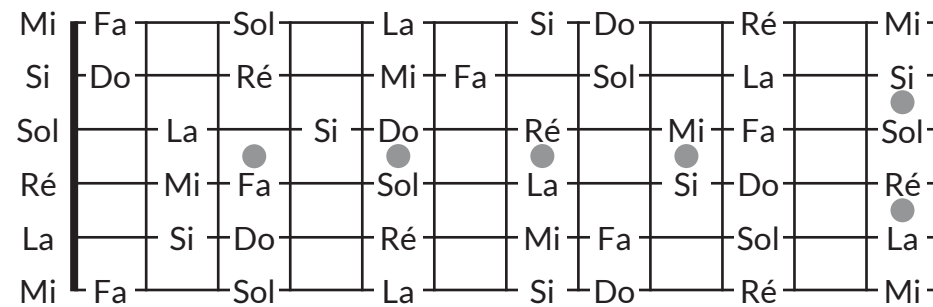
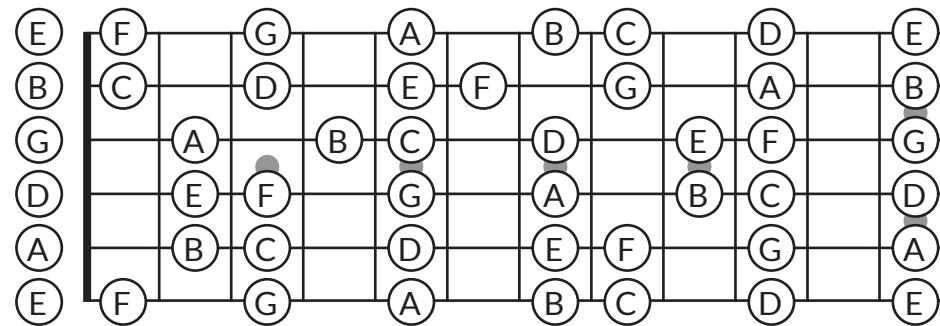

Connaissance du manche

Emplacement de la note LA

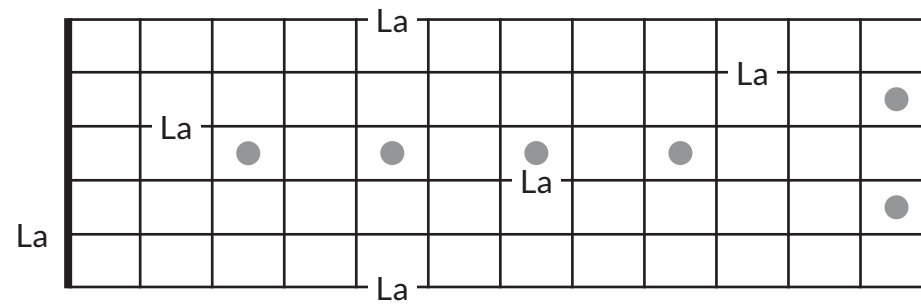
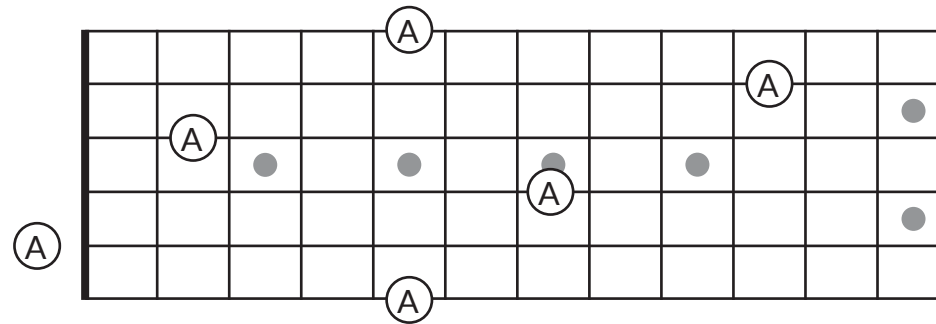

Connaissance du manche

Emplacement de la note SI

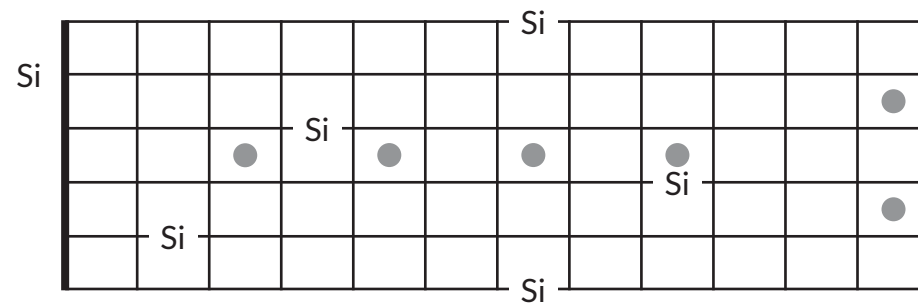
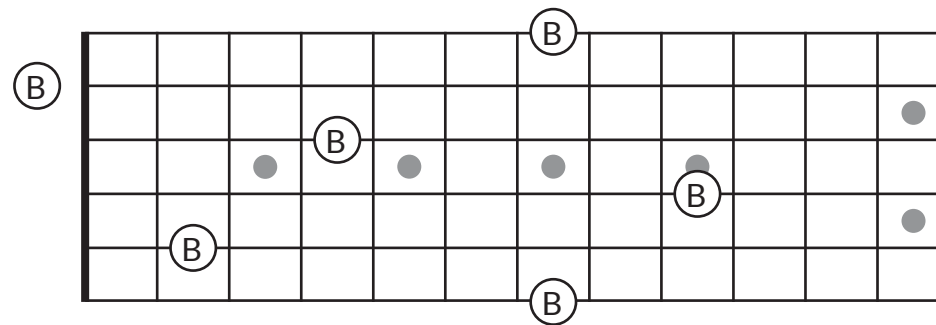

Connaissance du manche

Emplacement de la note DO

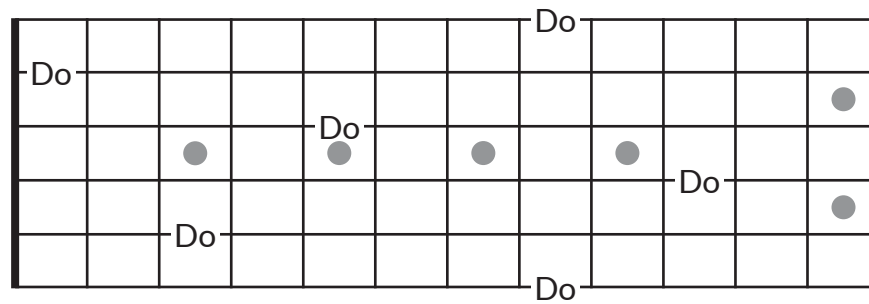
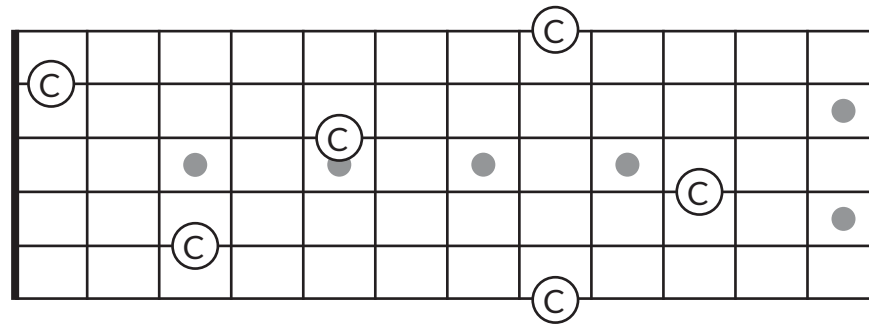

Connaissance du manche

Emplacement de la note RÉ

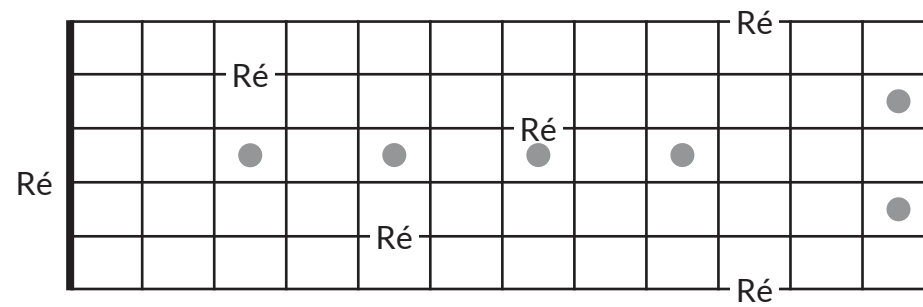
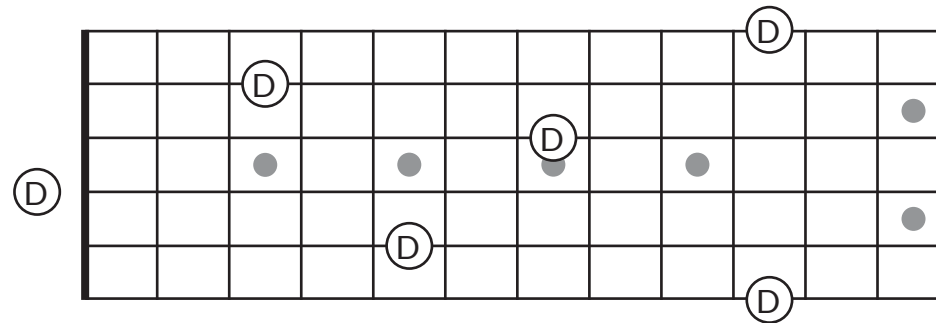

Connaissance du manche

Emplacement de la note MI

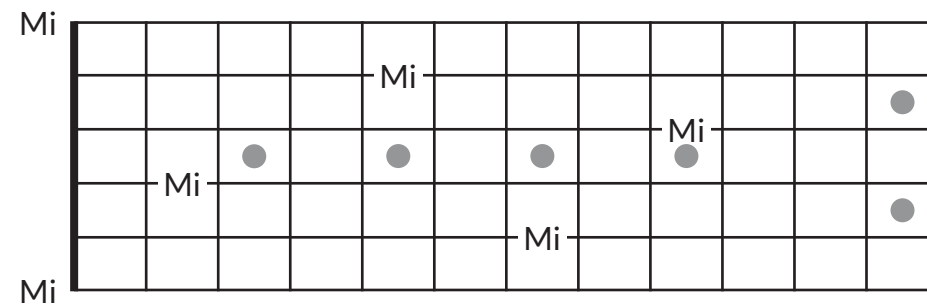
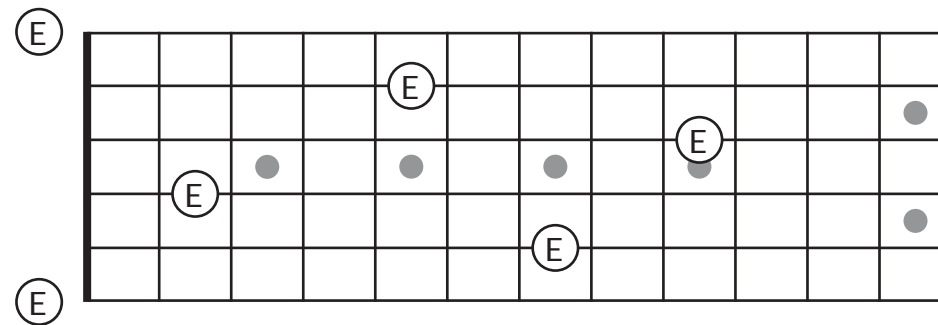

Connaissance du manche

Emplacement de la note FA

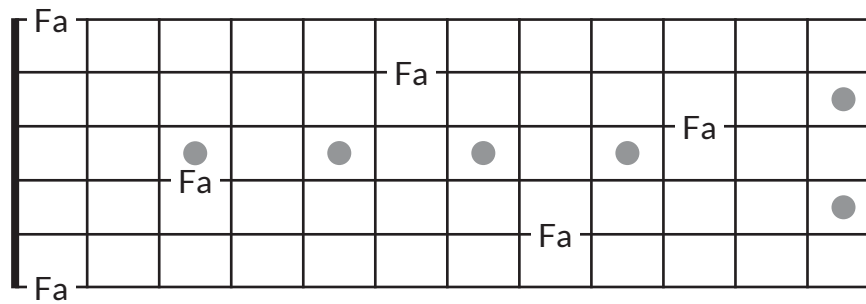
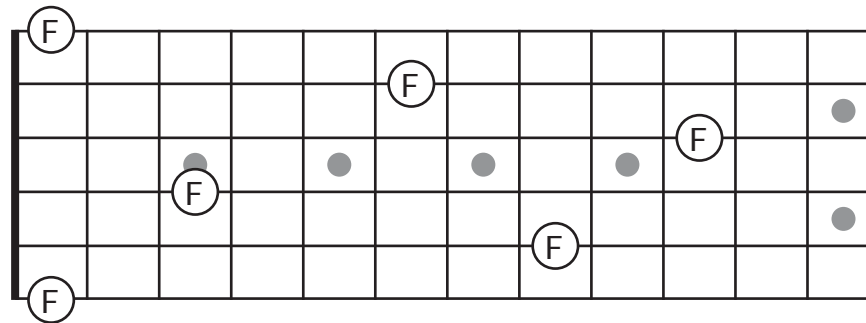

Connaissance du manche

Emplacement de la note SOL

